

# Bridge Amplifier for 2 x 1/4 Strain Gage Bridge

## DABI AD2T-2Q

### Features

- Industrial bridge amplifier for 2 x 1/4 S/G bridge
- For cyclical and static applications with reset function
- Current output
- Protection class IP 65



### Electrical Data

Output signal	4 - 20 mA calibrated
Characteristic curve deviation	0250 < 0,5% 0500 < 0,25% 1000 < 0,2%
Supply voltage range	14 - 33 VDC
Current draw	< 90 mA < 70 mA @ 24 VDC
Bridge excitation	approx. 9 VDC
S/G bridge resistance	350 Ω
Burden	< 400 Ω
Tare accuracy	0250 < 30 μA 0500 < 20 μA 1000 < 16 μA
Reset input	active 5 - 33 VDC < 2 mA inactive < 1 VDC
Tare range	±6 mV/V
Reset puls	> 1 ms
Reset settle time	< 5 ms
Frequency range (-3 dB)	1'000 Hz
Noise	(0 ... 5 kHz) 0250 < 30 μA <sub>pp</sub> 0500 < 20 μA <sub>pp</sub> 1000 < 16 μA <sub>pp</sub>

### Mechanical Data

Control connection	5 pin male (Series 713)
Sensor connection	4 pin female (Series 712)
Enclosure	aluminum anodised

### Environmental Conditions

Operating temp. range	-25...+85 °C
Specified temp. range	0...+70 °C
Storage temperature	-40...+100 °C
Protection class	IP 65
EMC	EN 61000-6-2 Immunity EN 61000-6-3 Emission

### Order Code

DABI AD2T-2Q  /C

Gain

**0250** 0250 με = 4 - 20 mA  
**0500** 0500 με = 4 - 20 mA  
**1000** 1000 με = 4 - 20 mA

/C Tension leads to a positive output signal

### Dimensions (mm)

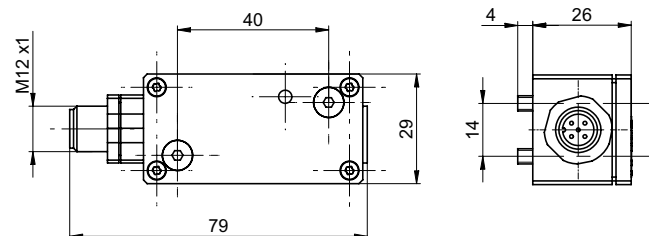

### Delivery Contents

- Mounting screw 2 pcs. M4 x 30

### Accessories (not included in delivery)



Connector female, control side, 5-pin, Part No. 10135462  
max. cable length 20 m

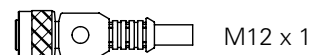

Connector female with cable, control side, 5-pin

ESG 34CH0200G 5-pin (shielded) 2 m, PUR,  
(Part No. 11046264)

ESG 34CH0500G 5-pin (shielded) 5 m, PUR,  
(Part No. 11046266)

ESG 34CH1000G 5-pin (shielded) 10 m, PUR,  
(Part No. 10155587)

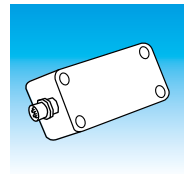

Electrical Connection

Sensor side Series 712

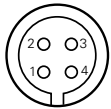

Pin	Signal
1	DMS 1 EXC.+
2	DMS 2 SIG.-
3	DMS 3 SIG.+
4	DMS 4 EXC.-

Control side Series 713



Pin number	Signal
1	+Vs
2	n.c.
3	GND
4	+I <sub>OUT</sub>
5	Reset

S/G Bridge

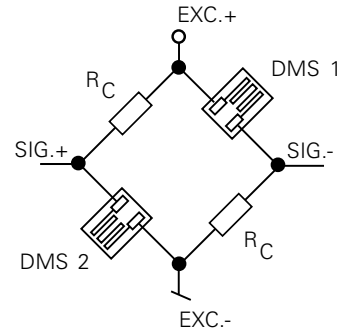

Control

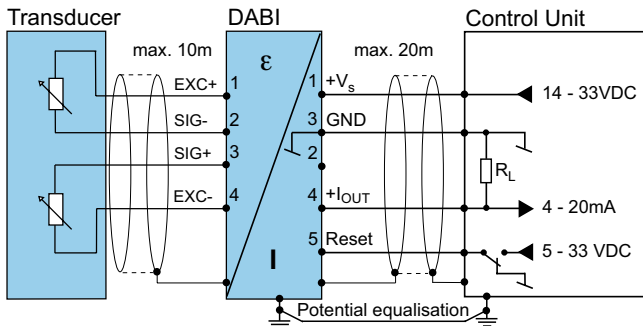

Reset Function

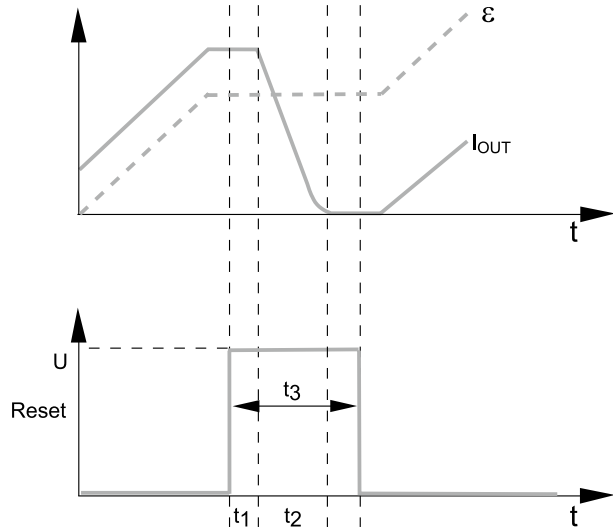

I <sub>OUT</sub>	Output signal
mV/V	Input signal
Reset	Reset input (active high)
t <sub>1</sub>	Reset delay (< 0,3 ms)
t <sub>2</sub>	Reset time (< 5 ms)
t <sub>3</sub>	Reset impuls (> 1 ms)